

This drawing is confidential and must not be reproduced or used without the consent of EXM

Ce dessin est confidentiel et ne doit pas être reproduit ou utilisé sans le consentement de EXM

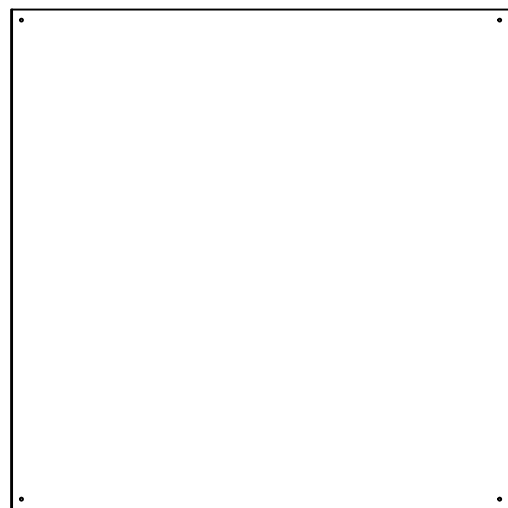

TOP



BACK

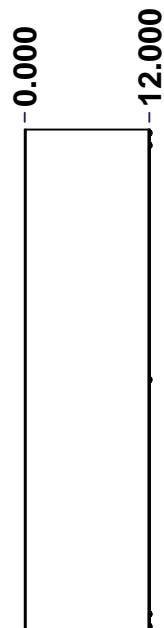

LEFT

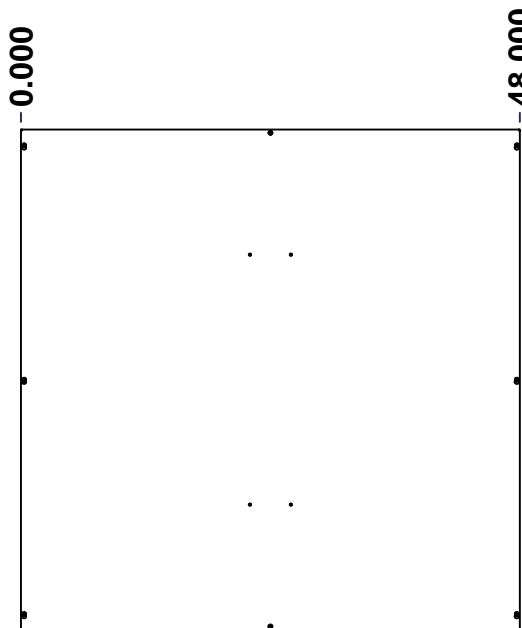

FRONT

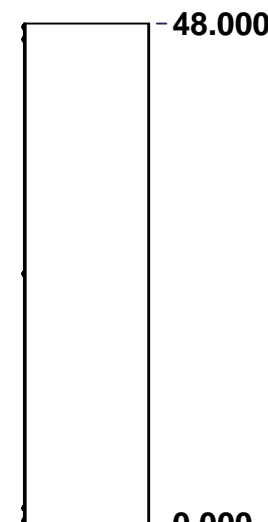

RIGHT

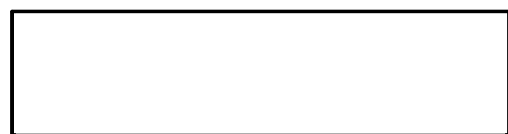

BOTTOM

No.	Revisions	Date	By/Par
1	update	21/10/2013	MichelP

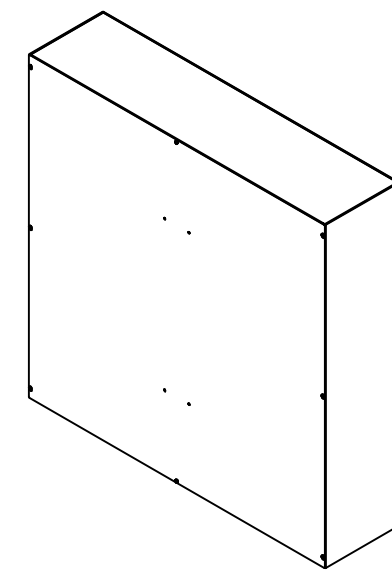

Isometric View

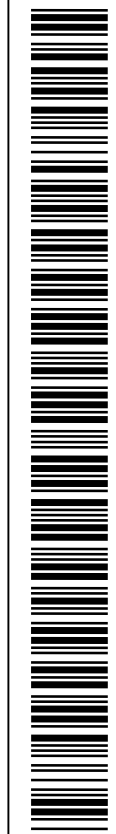

Tél: (450) 979-4373  
 Fax: (450) 979-4626  
[www.exmweb.com](http://www.exmweb.com)

Flatness  
Aplatissement  
Max 3.0mm  
Projection

Customer Client	Date
Drawn By / Dessiné Par: BoxCad: Annie	Date: 21/10/2013
Material / Matière: 14 Ga H.R.P. & O. (1.7mm)	
Color / Couleur: Asa-61 Grey	Finish / Fini: Smooth
Description: 1100DFN 48" x 48" x 12" Enclosure Assembly	Detail Rev.

SEE BILL OF MATERIAL ON LAST PAGE

Part Number / Numéro Pièce: <b>1100DF484812N</b>	Rev. 1	1
		2

This drawing is confidential and must not be reproduced or used without the consent of EXM

Ce dessin est confidentiel et ne doit pas être reproduit ou utilisé sans le consentement de EXM

NOTE	
ITEM	DESCRIPTION
1	NEMA 1 Enclosure
2	C/W Standard ground provision on box and cover
3	W/O Standard door stiffener
4	W/O Inner panel
5	W/O Inner panel mounting provision

No.	Revisions	Date	By/Par
1	update	21/10/2013	MichelP

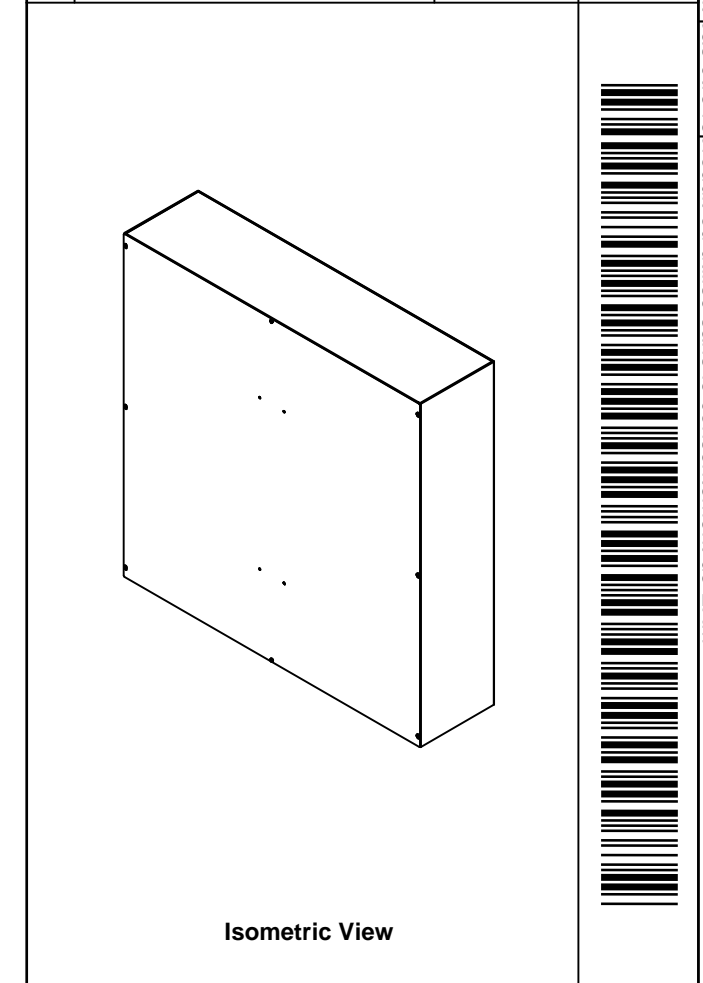

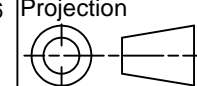
 Tél: (450) 979-4373 Fax: (450) 979-4626 <a href="http://www.exmweb.com">www.exmweb.com</a>		Flatness Aplatissement Max 3.0mm Projection 
Customer Client	Date	
Drawn By Dessiné Par	BoxCad: Annie	Date 21/10/2013
Material Matière	14 Ga H.R.P. & O. (1.7mm)	
Color Couleur	Asa-61 Grey	Finish Fini Smooth
Description 1100DFN 48" x 48" x 12" Enclosure Assembly		Detail Rev.
Part Number Numéro Pièce	<b>1100DF484812N</b>	Rev. 2 <b>1</b>

Qty	Part Number	Rev	Description
8	STK-Q-05020	5	M5 x 8mm Thread Rolling Screw
1	1100DF484812NC	1	1100DFN 48" x 48" Cover
1	1100DF484812NB	1	1100DFN 48" x 48" x 12" Body
Parts List			

This drawing is confidential and must not be reproduced or used without the consent of EXM

Ce dessin est confidentiel et ne doit pas être reproduit ou utilisé sans le consentement de EXM

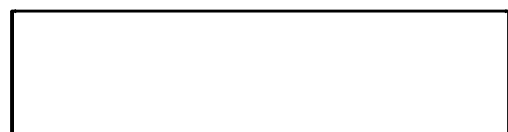

TOP

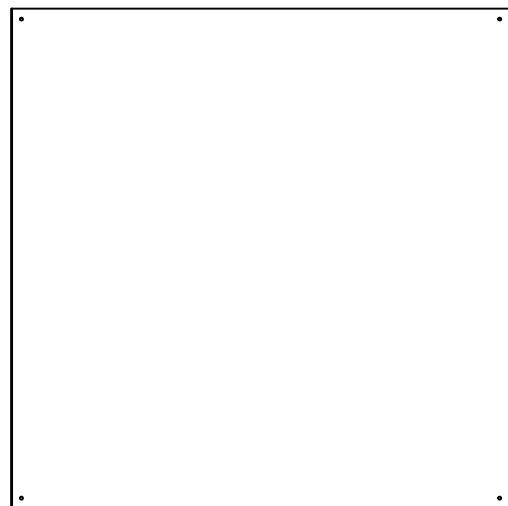

BACK



LEFT

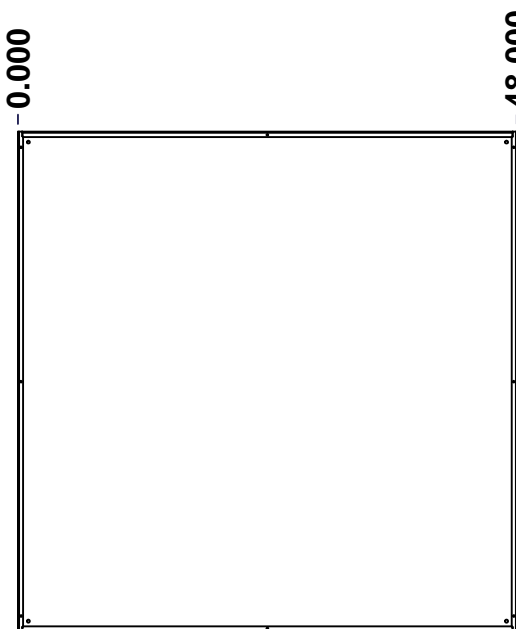

FRONT

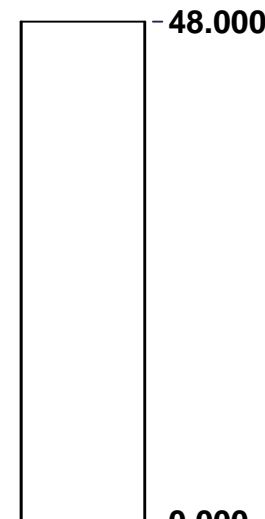

RIGHT

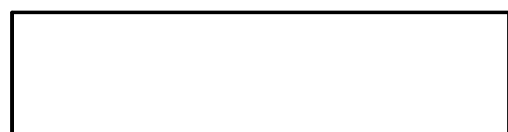

BOTTOM

No.	Revisions	Date	By/Par
1	update	21/10/2013	MichelP

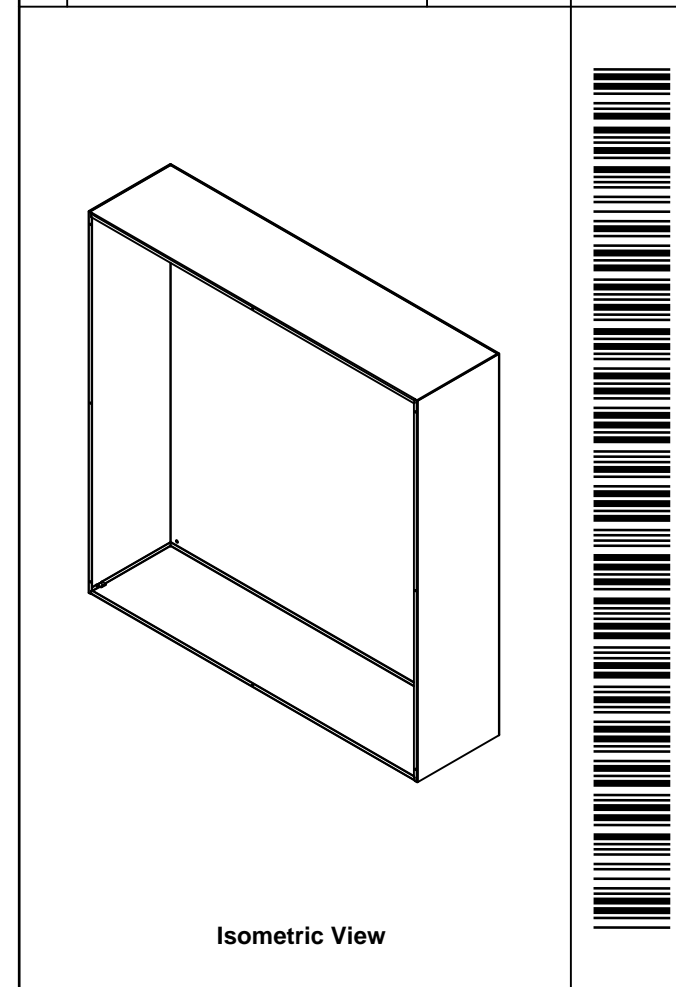

Isometric View

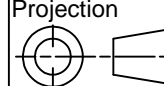

 Tél: (450) 979-4373 Fax: (450) 979-4626 <a href="http://www.exmweb.com">www.exmweb.com</a>		Flatness Aplatissement Max 3.0mm
Projection 		Customer Client
Drawn By Dessiné Par BoxCad: Annie		Date 21/10/2013
Material Matière 14 Ga H.R.P. & O. (1.7mm)		
Color Couleur Asa-61 Grey	Finish Fini Smooth	
Description 1100DFN 48" x 48" x 12" Body		Detail Rev.
Part Number Numéro Pièce <b>1100DF484812NB</b>		Rev. 1 7

SEE BILL OF MATERIAL ON LAST PAGE

This drawing is confidential and must not be reproduced or used without the consent of EXM

Ce dessin est confidentiel et ne doit pas être reproduit ou utilisé sans le consentement de EXM

No.	Revisions	Date	By/Par
1	update	21/10/2013	MichelP

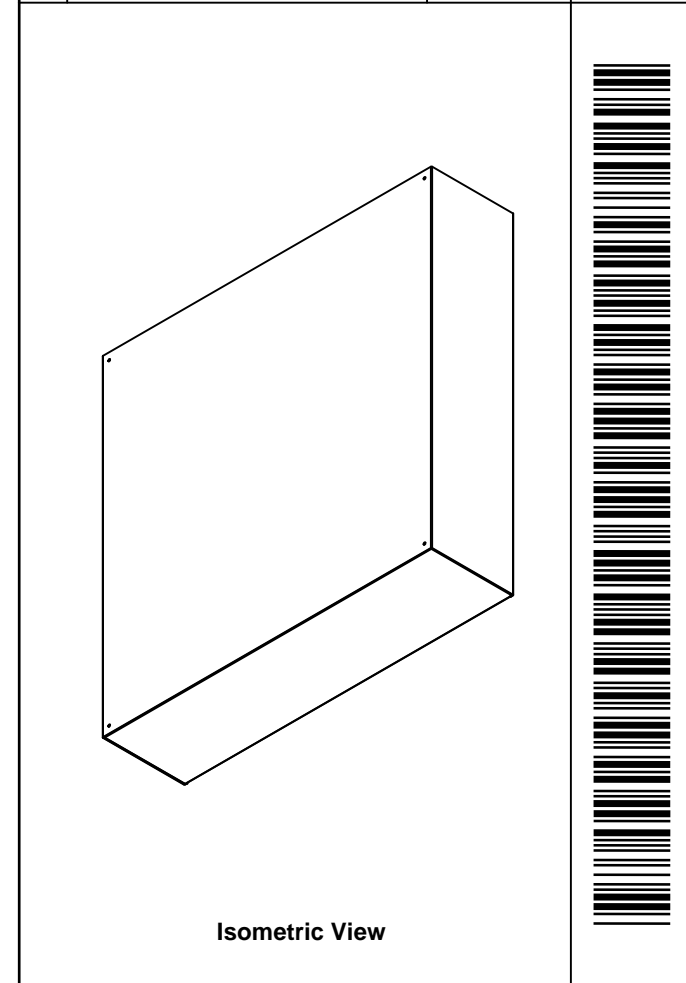

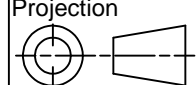
 Tél: (450) 979-4373 Fax: (450) 979-4626 <a href="http://www.exmweb.com">www.exmweb.com</a>		Flatness Aplatissement Max 3.0mm Projection 
Customer Client	Date	
Drawn By Dessiné Par	BoxCad: Annie	Date 21/10/2013
Material Matière	14 Ga H.R.P. & O. (1.7mm)	
Color Couleur	Asa-61 Grey	Finish Fini Smooth
Description		Detail Rev.
1100DFN 48" x 48" x 12" Body		
Part Number Numéro Pièce	Rev.	7
<b>1100DF484812NB</b>	<b>1</b>	<b>7</b>

Qty	Part Number	Rev	Description
1	STK-P-02400S	0	Powder Paint (Asa-61 Grey / Smooth)
1	1100DF484812NT-P	1	1100DFN 48" x 12" Top Part
1	1100DF484812NBT-P	1	1100DFN 48" x 12" Bottom Part
1	1100DF484812NB-P	1	1100DFN 48" x 48" x 12" Body Part
Parts List			

This drawing is confidential and must not be reproduced or used without the consent of EXM

Ce dessin est confidentiel et ne doit pas être reproduit ou utilisé sans le consentement de EXM

TOP

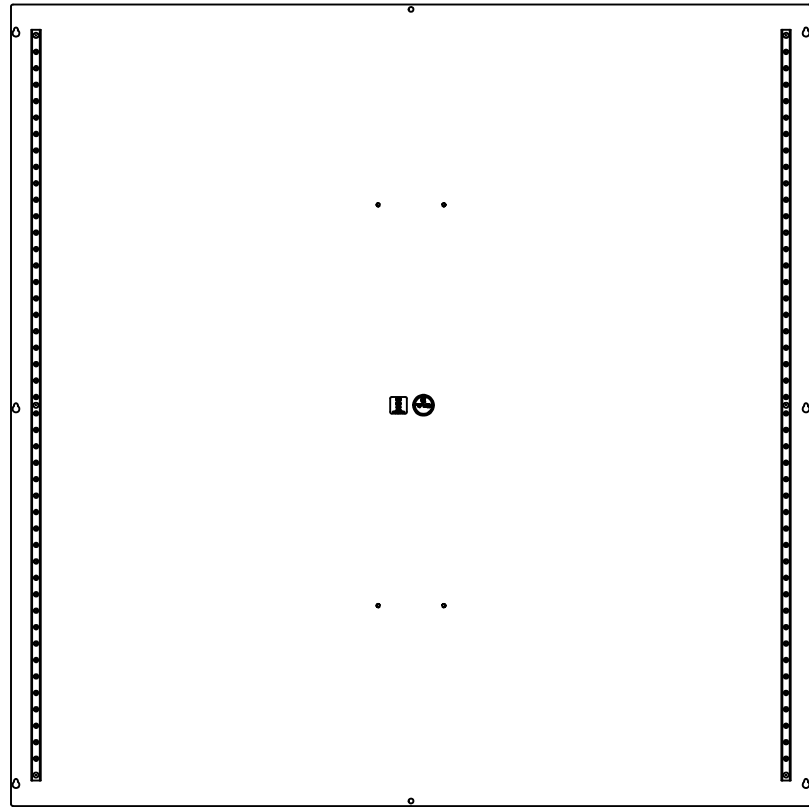

BACK

LEFT

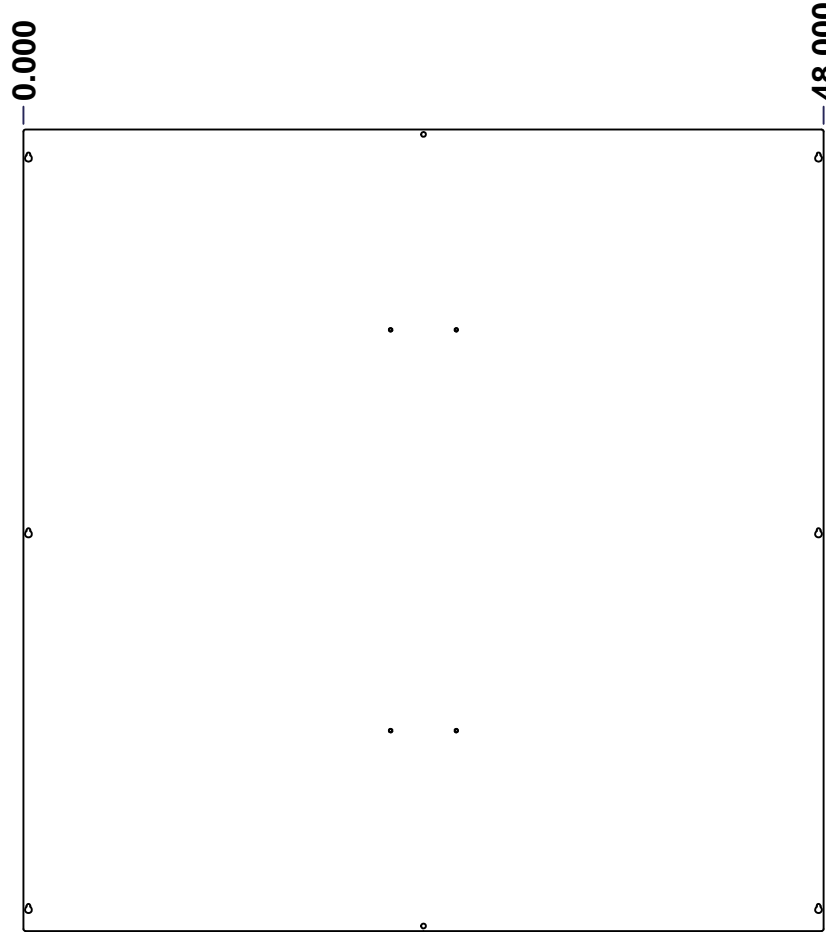

FRONT

RIGHT

BOTTOM

No.	Revisions	Date	By/Par
1	update	21/10/2013	MichelP

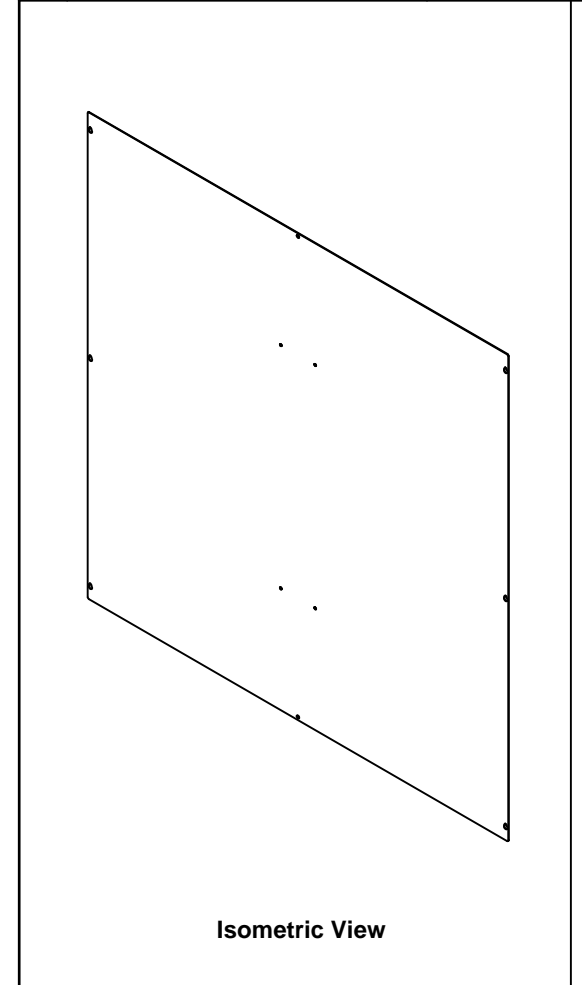

Isometric View

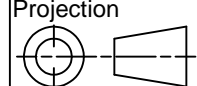

 Tél: (450) 979-4373 Fax: (450) 979-4626 <a href="http://www.exmweb.com">www.exmweb.com</a>		Flatness Aplatissement Max 3.0mm Projection 
Customer Client	Date	
Drawn By Dessiné Par	BoxCad: Annie	Date 21/10/2013
Material Matière	16 Ga H.R.P. & O. (1.4mm)	
Color Couleur	Asa-61 Grey	Finish Fini Smooth
Description	Detail Rev.	
1100DFN 48" x 48" Cover		
Part Number Numéro Pièce	Rev. 1	3
<b>1100DF484812NC</b>	<b>1</b>	

SEE BILL OF MATERIAL ON LAST PAGE

This drawing is confidential and must not be reproduced or used without the consent of EXM

Ce dessin est confidentiel et ne doit pas être reproduit ou utilisé sans le consentement de EXM

No.	Revisions	Date	By/Par
1	update	21/10/2013	MichelP

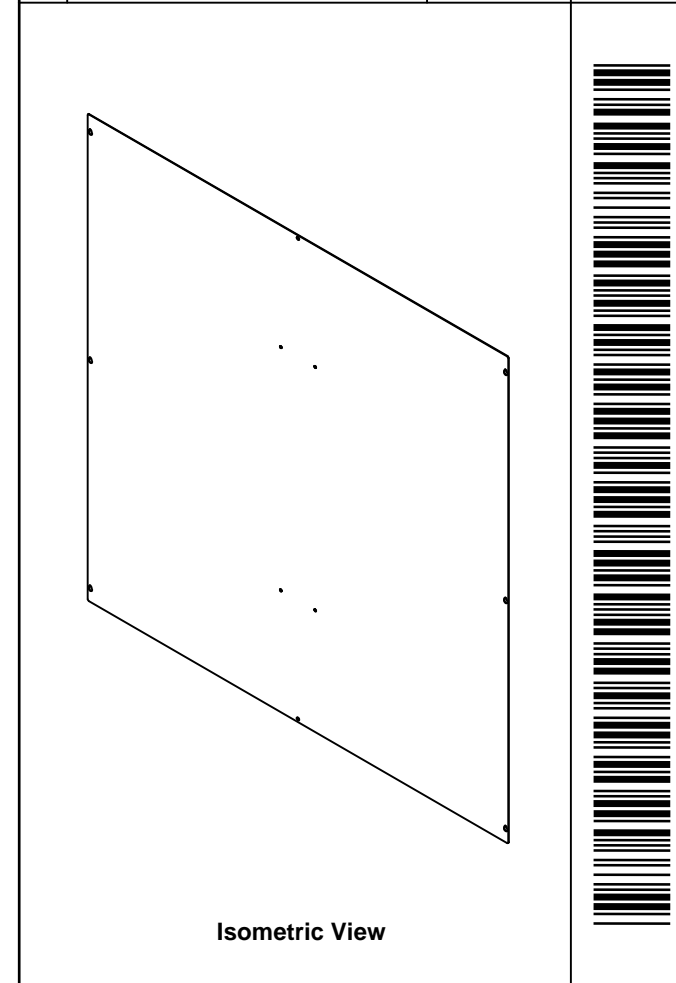

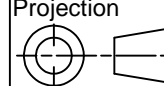
 Tél: (450) 979-4373 Fax: (450) 979-4626 <a href="http://www.exmweb.com">www.exmweb.com</a>		Flatness Aplatissement Max 3.0mm Projection 
Customer Client	Date	
Drawn By Dessiné Par	BoxCad: Annie	Date 21/10/2013
Material Matière	16 Ga H.R.P. & O. (1.4mm)	
Color Couleur	Asa-61 Grey	Finish Fini Smooth
Description	Detail Rev.	
1100DFN 48" x 48" Cover		
Part Number Numéro Pièce	Rev.	3
<b>1100DF484812NC</b>	<b>1</b>	<b>3</b>

Qty	Part Number	Rev	Description
2	STK-Q-46020-48	3	5412 ES Vertical Door Stiffener 48"
1	STK-S-00950	1	UL 74SL Pull-Box Sticker
1	STK-S-00800	0	CSA Electrical Box Sticker
1	STK-P-02400S	0	Powder Paint (Asa-61 Grey / Smooth)
1	1100DF484812NC-P	1	1100DFN 48" x 48" Cover Part
Parts List			