









BOLLARD RETROFITS 360° OMNI DIRECTIONAL DESIGN

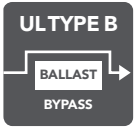

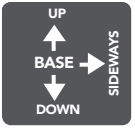
 120-277V VOLTAGE*	 E26 / EX39 MEDIUM + MOGUL BASES	 ULTYPE B BALLAST BYPASS	 -40°F TO 122°F OPERATING TEMP	 UP BASE DOWN SIDEWAYS MOUNTING	 6kA SURGE PROTECTION	 80+ CRI	 L70 50,000 RATED LIFE	 5 YEAR WARRANTY WARRANTY
---	---	---	--	--	---	--	--	---

three color temps in one



change color temperatures with the click of a switch

- Default setting is 4000K but can be changed to 3000K or 5000K with a flip of a switch.
- Available in 11W, 14W, 18W & 24W models replacing up to 150W HID.
- FlexColor allows for a reduction of skus needed to be stocked.
- Multi-directional mounting capability & 360° design. Use base down, base up or base sideways without affecting performance.
- Pretested & potted drivers are burnt in 3x prior to shipping and protected against vibration & moisture.
- Expertly engineered to work efficiently in enclosed fixtures & damp environments, while also protected against insects & dust.
- Dual stage MOV protection with integrated 6kA surge.

PART #	UPC	REPLACES	WATTAGE	LUMENS	CCT (K)**	BASE	DLC CODE
LED-8037E345-A	844006059378	50W	11W	1550/1610/1650	3000K/4000K/5000K	E26	N/A
LED-8038E345-A	844006059392	70W	14W	1850/1950/1990	3000K/4000K/5000K	E26	N/A
LED-8039E345-A	844006059415	100W	18W	2450/2560/2610	3000K/4000K/5000K	E26	N/A
LED-8039M345-A	844006059439	100W	18W	2450/2560/2610	3000K/4000K/5000K	EX39	P1E5A4JY
LED-8029E345-A	844006059453	150W	24W	3170/3330/3360	3000K/4000K/5000K	E26	N/A
LED-8029M345-A	844006059477	150W	24W	3170/3330/3360	3000K/4000K/5000K	EX39	PP4D3CHN

* See page 2 for 347 volt options for Canada 
 ** Default setting is 4000K.



LIGHT EFFICIENT DESIGN HEADQUARTERS 188 S. Northwest Highway • Cary, IL 60013
 INNOVATION & MANUFACTURING CENTER 30 Log Bridge Road, Building 200 • Middleton, MA 01949
 847.380.3540 • led-llc.com

BOLLARD RETROFITS 360° OMNI DIRECTIONAL DESIGN

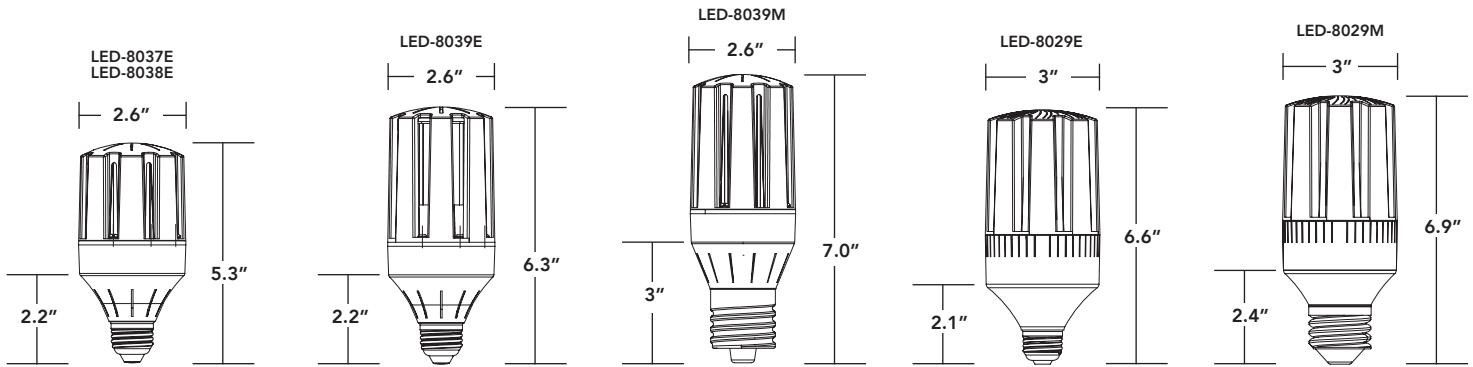

ORDERING GUIDE

PART #	UPC	REPLACES	WATTAGE	LUMENS	CCT (K)	BASE	DLC CODE
LED-8037E345-A	844006059378	50W	11W	1550/ 1610 /1650	3000K/ 4000K /5000K	E26	N/A
LED-8038E345-A	844006059392	70W	14W	1850/ 1950 /1990	3000K/ 4000K /5000K	E26	N/A
LED-8039E345-A	844006059415	100W	18W	2450/ 2560 /2610	3000K/ 4000K /5000K	E26	N/A
LED-8039M345-A	844006059439	100W	18W	2450/ 2560 /2610	3000K/ 4000K /5000K	EX39	P1E5A4JY
LED-8029E345-A	844006059453	150W	24W	3170/ 3330 /3360	3000K/ 4000K /5000K	E26	N/A
LED-8029M345-A	844006059477	150W	24W	3170/ 3330 /3360	3000K/ 4000K /5000K	EX39	PP4D3CHN

347 VOLT OPTIONS FOR CANADA

PART #	UPC	REPLACES	WATTAGE	LUMENS	CCT (K)	BASE	DLC CODE
LED-8037E345C-A	844006059385	50W	11W	1550/ 1610 /1650	3000K/ 4000K /5000K	E26	N/A
LED-8038E345C-A	844006059408	70W	14W	1850/ 1950 /1990	3000K/ 4000K /5000K	E26	N/A
LED-8039E345C-A	844006059422	100W	18W	2450/ 2560 /2610	3000K/ 4000K /5000K	E26	N/A
LED-8039M345C-A	844006059446	100W	18W	2450/ 2560 /2610	3000K/ 4000K /5000K	EX39	P6QZD1X9
LED-8029E345C-A	844006059460	150W	24W	3170/ 3330 /3360	3000K/ 4000K /5000K	E26	N/A
LED-8029M345C-A	844006059484	150W	24W	3170/ 3330 /3360	3000K/ 4000K /5000K	EX39	PO6ZZ1S0



LIGHT EFFICIENT DESIGN HEADQUARTERS 188 S. Northwest Highway • Cary, IL 60013
 INNOVATION & MANUFACTURING CENTER 30 Log Bridge Road, Building 200 • Middleton, MA 01949
 847.380.3540 • led-llc.com