

Flush Service Floor Boxes

Floor Boxes for Single Short-Strap Receptacles or Communications

Service Fitting Application

78 and 88 Series Floor Boxes provide flush service for power or communications and data. They can be used for either carpet or tile applications.

78 Series



78SC

- Cast iron, watertight body, semi-adjustable
- Painted silver enamel inside and out for additional corrosion resistance
- Exterior leveling screws and threaded vertical adjusting ring permit adjustment to meet finish floor
- Shipped complete with expandable cap to prevent ingress of concrete during pour
- 3/4" threaded conduit openings
- Uses P90 Series MopTite® covers

88 Series



88-D

- Stamped steel, concrete-tight, semi-adjustable
- Electro-galvanized body and hardware
- Exterior leveling screws and threaded vertical adjusting ring permit adjustment to meet finish floor
- Shipped complete with expandable cap to prevent ingress of concrete during pour
- 1/2" and 3/4" knockouts — all bottom knockouts accessible
- Uses P90 Series MopTite® covers



CAT. NO.	DESCRIPTION	STD. CTN.
78SC	Cast-Iron Single-Gang Floor Box with 3/4" Conduit Tapping	4
78-S	Cast-Iron Single-Gang Floor Box (shallow)	4
88-D	Stamped-Steel Single-Gang Floor Box with 1/2" and 3/4" Conduit Tapping	4
88-S	Shallow Version Stamped Steel	4

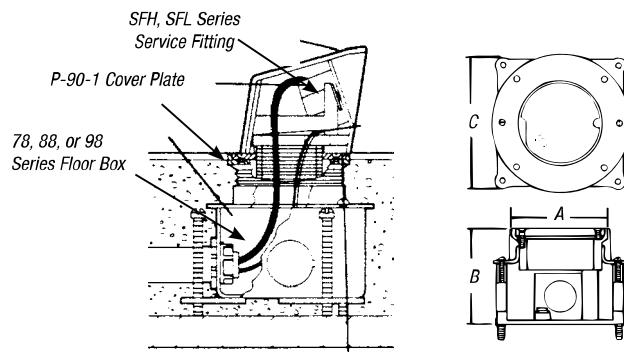

Engineering Data



CAT. NO.	DIMENSIONS (IN.)			BEFORE POUR ADJ. (IN.)	AFTER POUR ADJ. (IN.)	MAXIMUM CAPACITY CU. IN.	STANDARD CONDUIT TAPPING (IN.)
	A	B	C				
78SC	3	2 1/16	3 3/8	2 1/2	3/4	24	3/4
78-S	3	2 3/8	3 3/8	1 1/2	3/4	20	3/4
88-D	3	3 1/4	5 3/4	2 1/2	3/4	29	—
88-S	3	2 3/4	5 3/4	1 1/2	3/4	23	—